



Warwick
PVC Perimeter
Trunking Systems

Incorporating

Britmac

CABLE MANAGEMENT SYSTEMS

WARWICK MODULAR PVC RANGE

The WARWICK PVC modular trunking range has been designed and manufactured using the expertise from two of the longest established names in British Electrical manufacturing, Crabtree and Britmac. Crabtree, established in 1919 is a leader in electrical accessories in both U.K. and overseas markets and Britmac, one of the forerunners in Cable Management and flat plate accessories, have combined to develop the new WARWICK range to compliment an already large electrical installation equipment offering.

Both Crabtree and Britmac are part of Electrium, a major supplier to the electrical installation industry, both have extensive nationwide distributor coverage and are used on many specification projects.

The new WARWICK range can be mounted at either Dado or Skirting level and can be purchased as a standard system for hard wiring or with a factory fitted 63Amp bus-bar system in the centre compartment of the trunking.

- WARWICK accepts standard "Crabtree" wiring accessories
- WARWICK accepts 30mm deep socket boxes
- WARWICK accepts 63AMP 4 Bar Bus-Bar track
- WARWICK accepts a full range of complimentary fittings (bends, corners etc.)
- WARWICK accepts ample cable capacity
- WARWICK accepts integration with other surface products



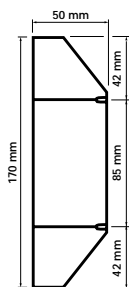

WARWICK 1

- Base Unit
- Angled Top and Bottom Covers
- Main Centre Cover

See page 4

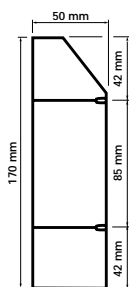

WARWICK 2

- Base Unit
- Angled Top Cover
- Main Centre Cover
- Square Bottom Cover

See page 5

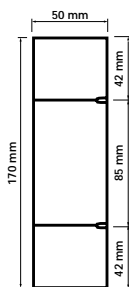

WARWICK 3

- Base Unit
- Square Top and Bottom Covers
- Main Centre Cover

See page 6

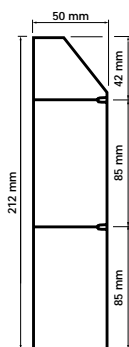

WARWICK 4

- Base Unit
- Base Extension
- Angled Top Cover
- 2 x Main Covers

See page 7

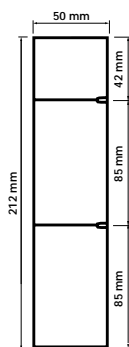

WARWICK 5

- Base Unit
- Base Extension
- Square Top Cover
- 2 x Main Covers

See page 8



QUICK GUIDE TO FIVE PVC PROFILES

	WARWICK 1 Ref No	WARWICK 2 Ref No	WARWICK 3 Ref No	WARWICK 4 Ref No	WARWICK 5 Ref No
Trunking Pack	BCL1	BCL2	BCL3	BCL4	BCL5
Internal Bend	BCL1/IB	BCL2/IB	BCL3/IB	BCL4/IB	BCL5/IB
External Bend	BCL1/EB	BCL2/EB	BCL3/EB	BCL4/EB	BCL5/EB
Flat Angle 90° (Downward)	BCL1/FAD	BCL2/FAD	BCL3/FAD	BCL4/FAD	BCL5/FAD
Flat Angle 90° (Upward)	-	BCL2/FAU	-	BCL4/FAU	BCL5/FAU
Flat Tee (Downward)	BCL1/FTD	BCL2/FTD	BCL3/FTD	BCL4/FTD	BCL5/FTD
Flat Tee (Upward)	-	BCL2/FTU	-	BCL4/FTU	BCL5/FTU
Stop End - Left	BCL1/SEL	BCL2/SEL	BCL3/SEL	BCL4/SEL	BCL5/SEL
Stop End - Right	-	BCL2/SER	-	BCL4/SER	BCL5/SER
Coupler Pack	BCL1/CP	BCL2/CP	BCL3/CP	BCL4/CP	BCL5/CP
Angled Cable Retainer	BCL/ACR	BCL/ACR	-	BCL/ACR	-
Standard Cable Retainer	BCL/SCR	BCL/SCR	BCL/SCR	BCL/SCR	BCL/SCR
Square Cable Retainer	-	BCL/SQCR	BCL/SQCR	BCL/SQCR	BCL/SQCR
Single Gang Accessory Box	BCL/SGB	BCL/SGB	BCL/SGB	BCL/SGB	BCL/SGB
Twin Gang Accessory Box	BCL/TGB	BCL/TGB	BCL/TGB	BCL/TGB	BCL/TGB



ANGLED COVER SECTION
BCL/ACS Pack Quantity 5 x 3m

MAIN COVER
BCL/MC Pack Quantity 5 x 3m

SQUARE COVER SECTION
BCL/SCS Pack Quantity 5 x 3m

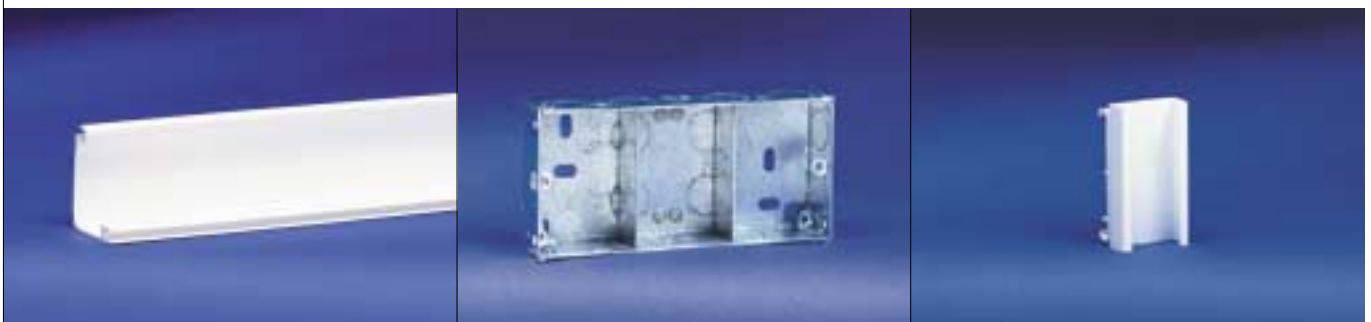

BASE EXTENSION
BCL/BE Pack Quantity 5 x 3m

FLUSH BACK BOX
BCL/FBB Pack Quantity 1

CROSSOVER BRIDGE PIECE
BCL/CBP Pack Quantity 5

METAL SCREENING

Should metal screening be required, aluminium sections can be supplied for both top and bottom sections of the trunking to ensure "spiking" does not occur. If screened data/telephone cables are being used within the wiring system internal metal screening is not needed.

ANGLED SECTION SCREEN **BCL/ASS**

Supplied in 1m lengths

SQUARE SECTION SCREEN **BCL/SSS**

Supplied in 1m lengths

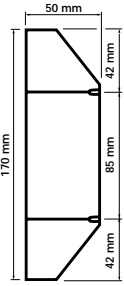

- Profile assembly includes:
- Base Section
 - 2 x Angled Covers
 - 1 x Main Cover

Overall Size: • 170mm x 50mm



TRUNKING PACK
BCL1 Pack Quantity 2 x 3m lengths



INTERNAL BEND
BCL1/IB Pack Quantity 1



EXTERNAL BEND
BCL1/EB Pack Quantity 1



FLAT ANGLE
BCL1/FAD Pack Quantity 1



FLAT TEE
BCL1/FTD Pack Quantity 1

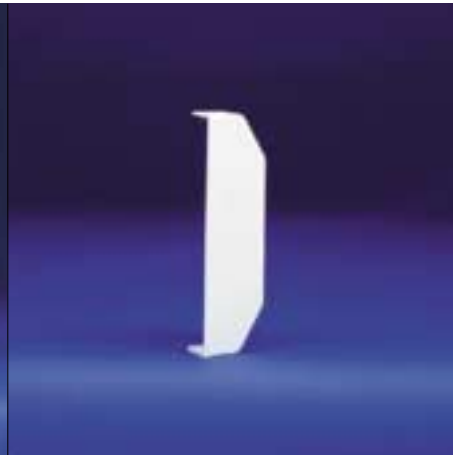

STOP END
BCL1/SEL Pack Quantity 1



COUPLER PACK
BCL1/CP Pack Quantity 5



ANGLED CABLE RETAINER
BCL/ACR Pack Quantity 10



SINGLE GANG ACCESSORY BOX
BCL/SGB Pack Quantity 10



TWIN GANG ACCESSORY BOX
BCL/TGB Pack Quantity 10

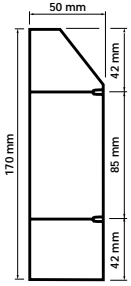

- Profile assembly includes:
- Base Section
 - 1 x Angled Cover
 - 1 x Main Cover
 - 1 x Square Cover
- Overall Size: • 170mm x 50mm



TRUNKING PACK
BCL2 Pack Quantity 2 x 3m lengths



INTERNAL BEND
BCL2/IB Pack Quantity 1



EXTERNAL BEND
BCL2/EB Pack Quantity 1



FLAT ANGLE (DOWNWARD)
BCL2/FAD Pack Quantity 1



FLAT ANGLE (UPWARD)
BCL2/FAU Pack Quantity 1



FLAT TEE (UPWARD)
BCL2/FTU Pack Quantity 1



FLAT TEE (DOWNWARD)
BCL2/FTD Pack Quantity 1



STOP END (LEFT)
BCL2/SEL Pack Quantity 1



STOP END (RIGHT)
BCL2/SER Pack Quantity 1



COUPLER PACK
BCL2/CP Pack Quantity 5



ANGLED CABLE RETAINER
BCL/ACR Pack Quantity 10



SINGLE GANG ACCESSORY BOX
BCL/SGB Pack Quantity 10



TWIN GANG ACCESSORY BOX
BCL/TGB Pack Quantity 10



SQUARE CABLE RETAINER
BCL/SQCR Pack Quantity 10

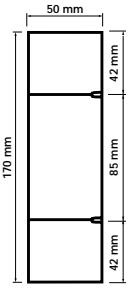

Profile assembly includes:

- Base Section
- 2 x Square Covers
- 1 x Main Cover

Overall Size: • 170mm x 50mm



TRUNKING PACK
BCL3 Pack Quantity 2 x 3m lengths



INTERNAL BEND
BCL3/IB Pack Quantity 1



EXTERNAL BEND
BCL3/EB Pack Quantity 1



FLAT ANGLE
BCL3/FAD Pack Quantity 1



FLAT TEE
BCL3/FTD Pack Quantity 1



STOP END
BCL3/SEL Pack Quantity 1



COUPLER PACK
BCL3/CP Pack Quantity 5



SQUARE CABLE RETAINER
BCL/SQCR Pack Quantity 10



SINGLE GANG ACCESSORY BOX
BCL/SGB Pack Quantity 10



TWIN GANG ACCESSORY BOX
BCL/TGB Pack Quantity 10

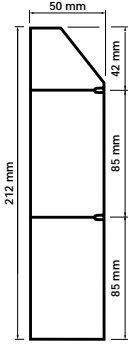

- Profile assembly includes:
- Base Section
 - 1 x Base Extension
 - 1 x Angled Cover
 - 2 x Main Covers
- Overall Size: • 212mm x 50mm



TRUNKING PACK
BCL4 Pack Quantity 2 x 3m lengths



INTERNAL BEND
BCL4/IB Pack Quantity 1



EXTERNAL BEND
BCL4/EB Pack Quantity 1



FLAT ANGLE (DOWNWARD)
BCL4/FAD Pack Quantity 1



FLAT ANGLE (UPWARD)
BCL4/FAU Pack Quantity 1



FLAT TEE (DOWNWARD)
BCL4/FTD Pack Quantity 1



FLAT TEE (UPWARD)
BCL4/FTU Pack Quantity 1



STOP END (LEFT)
BCL4/SEL Pack Quantity 1



STOP END (RIGHT)
BCL4/SER Pack Quantity 1



COUPLER PACK
BCL4/CP Pack Quantity 5



ANGLED CABLE RETAINER
BCL/ACR Pack Quantity 10



SINGLE GANG ACCESSORY BOX
BCL/SGB Pack Quantity 10



TWIN GANG ACCESSORY BOX
BCL/TGB Pack Quantity 10

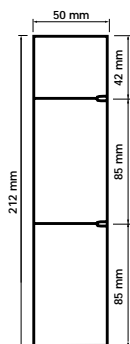

- Profile assembly includes:
- Base Section
 - 1 x Base Extension
 - 1 x Square Cover
 - 2 x Main Covers
- Overall Size: • 212mm x 50mm



TRUNKING PACK
BCL5 Pack Quantity 2 x 3m lengths



INTERNAL BEND
BCL5/IB Pack Quantity 1

EXTERNAL BEND
BCL5/EB Pack Quantity 1

FLAT ANGLE (DOWNWARD)
BCL5/FAD Pack Quantity 1



FLAT ANGLE (UPWARD)
BCL5/FAU Pack Quantity 1

FLAT TEE (DOWNWARD)
BCL5/FTD Pack Quantity 1

FLAT TEE (UPWARD)
BCL5/FTU Pack Quantity 1



STOP END (LEFT)
BCL5/SEL Pack Quantity 1

STOP END (RIGHT)
BCL5/SER Pack Quantity 1

COUPLER PACK
BCL5/CP Pack Quantity 5



SQUARE CABLE RETAINER
BCL/SQCR Pack Quantity 10

SINGLE GANG ACCESSORY BOX
BCL/SGB Pack Quantity 10

TWIN GANG ACCESSORY BOX
BCL/TGB Pack Quantity 10

- The Warwick Bus-Bar has been designed to fit into any of the five standard Warwick PVC trunkings.
- Available with a full range of accessories for easy installation.
- Single and double plug-in accessory boxes which locate into the Bus-Bar track and allow cable termination to standard 13A sockets.
- Safety Bus-Bar cover

- Fully integrated system
- WARWICK standard trunkings can be upgraded to a Bus-Bar system utilising full range of separate parts.
- The Bus-Bar has a standard configuration with 4 bars – Live, Neutral, Earth and a separate bar for a clean Earth requirement and Regulation 607. The bars are clearly marked on the connector blocks and the snap-in boxes. A standard 3-bar system can be achieved if required.

Bus-Bar lengths are supplied separately to allow flexibility on site, and can be ordered in varying lengths to suit the installation.

The Bus-Bar Assembly will fit into any Warwick PVC profile.

3 metre Length	BCL/BB3
2 metre Length	BCL/BB2
1 metre Length	BCL/BB1
1/2 metre Length	BCL/BB05

For installations requiring Bus-Bar, we strongly recommend the order is handled by the PROJECT SALES TEAM who offer a free installation design service.

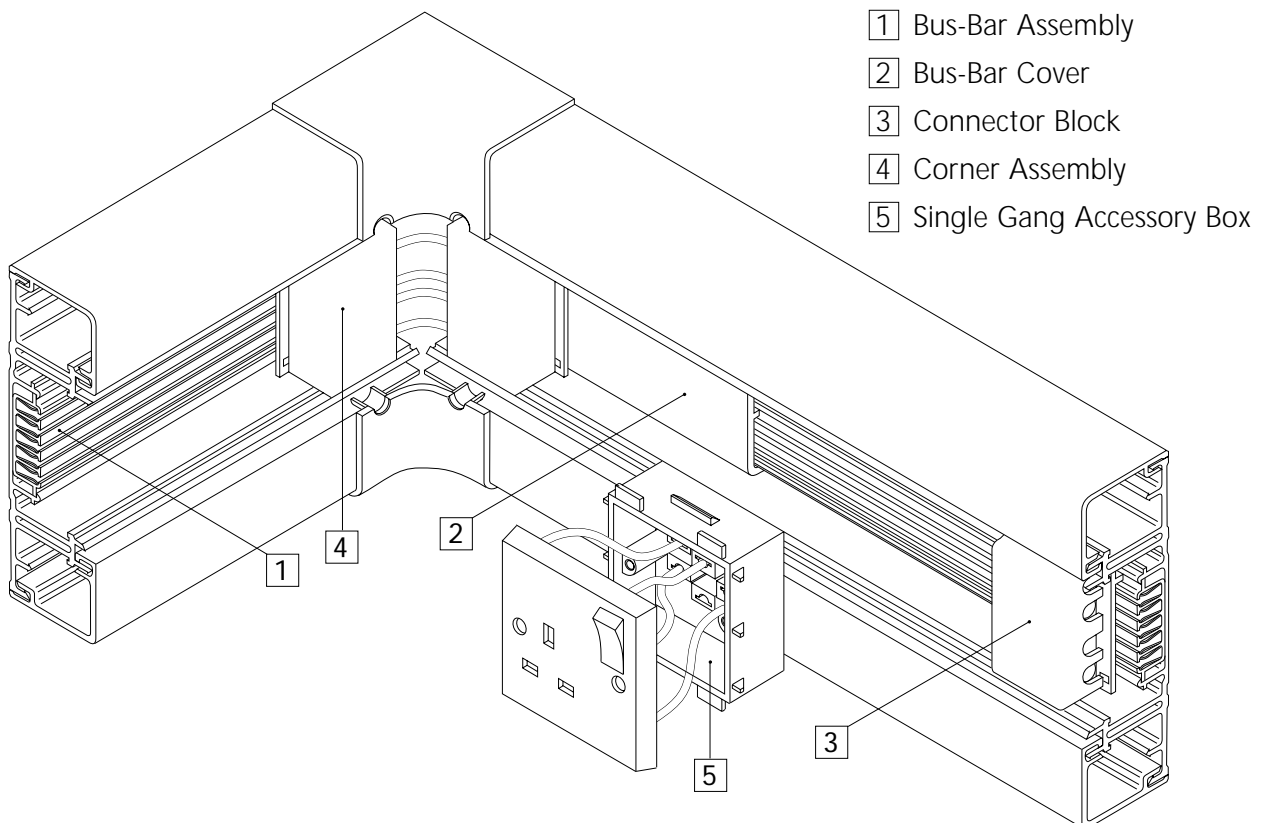

These accessories fit all five WARWICK profiles

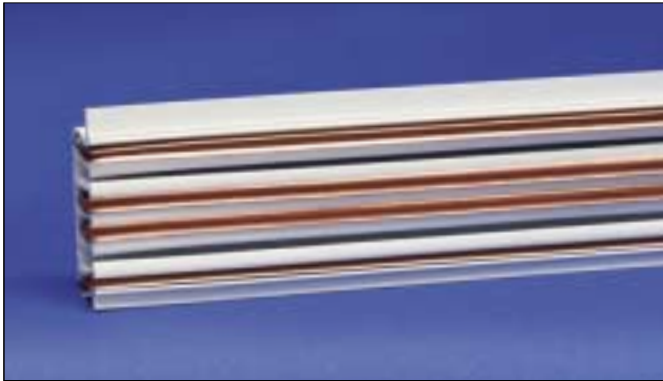

BUS-BAR ASSEMBLY
BCL/BB3 Standard Pack 1 x 3m



BUS-BAR COVER
BCL/BBC Standard Pack 4 x 3m



BUS-BAR END STOP (LEFT)
BCL/BBSL Standard Pack 1



BUS-BAR END STOP (RIGHT)
BCL/BBSR Standard Pack 1

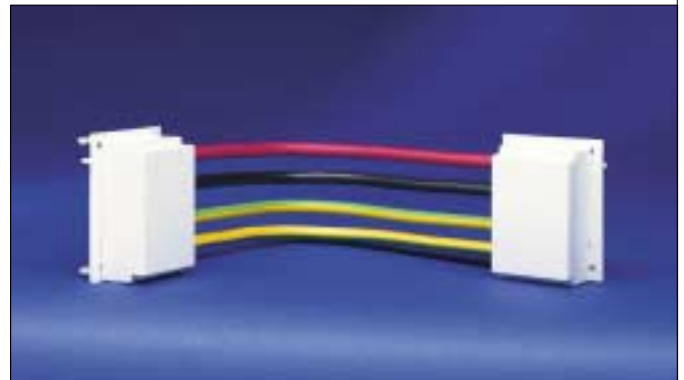

BUS-BAR CORNER ASSEMBLY
BCL/BBCA Standard Pack 1



BUS-BAR MAINS CONNECTOR BLOCK
BCL/BBMC Standard Pack 1



BUS-BAR SINGLE-GANG ACCESSORY BOX
BCL/BBSB Standard Pack 10



SINGLE GANG DATA/TELEPHONE BOX
BCL/SGB Standard Pack 10



BUS-BAR COUPLER BLOCK
BCL/BBCB Standard Pack 5



BUS-BAR TWIN-GANG ACCESSORY BOX
BCL/BBTB Standard Pack 10



TWIN GANG BOX
BCL/TGB Standard Pack 10

ELECTRICAL DATA

The Bus-Bar is rated at 63A, 250V AC., 50/60Hz single phase.

Average ambient temperature 35°C over 24 hour period.

SHORT CIRCUIT RATING

Short circuit protection provided by fuse-links BS88 and BS1361, 63A maximum.

Prospective current	16.5kA
Mechanical withstand	10kA peak
Thermal withstand	1.2kA for 0.4 seconds.

CABLE CAPACITY OF TERMINALS

Mains Connector Block	25mm ²
13A accessories	10mm ²

VOLT DROP

Bus-Bar (line & neutral)	3.3mV/A/m
Track Connector	0.44mV/A
Supply Connector	0.22mV/A

EARTH FAULT LOOP IMPEDANCE

The IEE wiring regulations require accurate determination of the total earth loop impedance, which must be low enough to ensure that the protective device will operate within the specified time, which for circuits incorporating socket outlets is 0.4 seconds. The values for the WARWICK Bus-Bar system for calculating the earth fault loop impedance are as follows.

Phase Bus-Bar:-
1.6m Ω /m of conductor

Earth Bus-Bar:-
1-6m Ω /m of conductor

Track Connector 0.4m Ω typical

STANDARDS

Trunking to: BS4678 Part 4

Bus-Bar trunking to
BSEN60439-2: 1993

Accessories to: BS1363 (1984)
BS 3676 :1: (1989)
BS 5733 (1979)

ASSEMBLY/INSTALLATION

The WARWICK Bus-Bar system has been designed so that no cutting of the Bus-Bar section is required, various lengths from 3 metres to 0.5 metres being available. **Plan the proposed runs accordingly.**

For installations requiring Bus-Bar, we strongly recommend the order is handled by the PROJECT SALES TEAM who offer a free installation design service.

- 1) Fix the base section to the wall, ensuring that the Crabtree/Britmac name is at the TOP (as per the standard sections).
- 2) When the straight trunking lengths have all been fixed and secured, the Bus-Bar sections can be snapped into place.
- 3) All the Bus-Bar couplers, corner assemblies and stop ends can now be fitted.
- 4) Once the whole Bus-Bar section has been connected together, positioning of all plug-in power back boxes can be snapped into the Bus-Bar.
- 5) At this point the Bus-Bar cover can be installed, ensuring the covers are fixed tight to the boxes with no gaps showing.
- 6) Back boxes for data/telephones can now be positioned and wired.
- 7) Should metal screening be required, this should be inserted in the top and bottom sections of the trunking prior to wiring of the data and telephone systems.
- 8) All internal wiring and installation should be checked before any external covers are fixed.
- 9) The snap-on external covers can now be installed.
- 10) Finally, the wiring of the power outlets and the data and telephone accessories should complete the installation.

GENERAL INFORMATION

Expansion/Contraction – Allowance should be made for thermal movement. A 5mm gap between each length of the trunking base is recommended. Couplers on the bases are not required.

Planning - if the trunking is to be utilised as a skirting system, sufficient clearance for lids and carpeting should be catered for.

Internal Bus-Bar Cover – Once the system has been made live, the internal cover must not be removed. Data/Telephone boxes can be installed without removing the Bus-Bar cover.

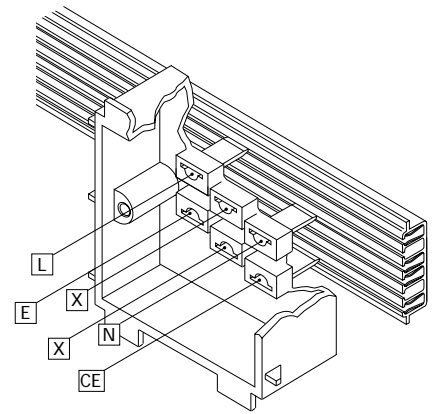
BUS-BAR CONFIGURATION

If clean earth bar is not required, no connection on bottom termination is necessary.

SITWORK

Perimeter systems are designed in accordance with I.E.E. regulations and allow installers to comply with these regulations. The above installation notes are for guidance purposes and to assist good practice and workmanship. It is the duty of the installer to ensure that I.E.E. regulations are being met with regard to the finished installation.

STANDARDS

Manufactured to comply with the requirements of BS4678: Part 4 (1982) and BSEN 50085-1 (1999).

The Electrium group of companies is registered for assessed capability to ISO 9002 Part 1.

The WARWICK range complies with all requirements of the 16th Edition of the IEE Regulations.

MANUFACTURE

All trunking components are manufactured from PVCu material. Base sections, covers and bus-bar base sections are extruded.

Bends, corners, stop ends, joint covers and accessory boxes are formed by injection moulding.

Flat angles and tees are factory pre-fabricated from standard profiles.

STRENGTH

High impact resistant. The material is formulated to comply with BS4678 Part4 (1982). Temperature classification -5 to +60°C for permanent application range.

FINISH

Manufactured in White Semi-glass finish.

FIRE RESISTANCE

The PVCu used in WARWICK trunking is non-propagating and complies with the requirements of BS476 parts 5 & 7 and BS4678 Part 4.

DEGREE OF PROTECTION

IP4X

THERMAL PROPERTIES

Water Absorbtion – Negligible
 Mineral Acids – Excellent
 Detergents – Excellent

Note:

Some solvents such as Ketones, Aromatics and Hydrocarbons should not be used on PVC trunking

CABLE CAPACITIES

The following table is from the 16th edition of the IEE Wiring Regulations: Guidance Note 1: Selection and Erection of equipment.

The table refers to single core PVC Insulating cables only.

**TABLE A5
CABLE FACTORS FOR TRUNKING**

Type of Conductor	Conductor Cross - Sect. Area	Term
Solid	1.5	7.1
	2.5	10.2
Standard	1.5	8.1
	2.5	11.4
	4.0	15.2
	6.0	22.9
	10.0	36.3

This Appendix is a method which can be used to determine the size of trunking necessary to accommodate cables of the same size, or different sizes.

The number of cables drawn into or laid in an enclosure of a wiring system shall be such that no damage is caused to the cables or to the enclosure during their installation.

For trunking each size of cable has been allocated a term, as has each trunking. To ascertain the size of trunking required, add together all the cable terms and compare against the trunking terms given in the following figures.

Note:

For power cables a space factor of 45% must apply, therefore, the following terms represent this in the internal area figures.

Angled Top/Bottom section:-
 Area 1176mm Term Value 532

Central section:-
 Area 3483mm Term Value 1576

Square Top/Bottom section:-
 Area 1507mm Term Value 682

Extended Bottom section:-
 Area 3499mm Term Value 1583

INSTALLATION RECOMMENDATIONS

- 1) The base section and extension base (if used) should be plug and screw fixed to the wall ensuring washers are used behind the screw head for a more secure fix.
- 2) All joints should have a 5mm gap to allow for expansion and base section corners should be mitred. The cutting of the base sections is not critical as the manufactured fittings cover the joints and overlap the trunking lids.
- 3) For cutting it is recommended that a fine tooth tenon or hacksaw is used. Use a sharp knife or file for trimming.
- 4) Should screening be required this can now be inserted into the relevant compartment.
- 5) Socket and data boxes can be positioned and wiring can begin.
- 6) On completion of all wiring, the covers, joint covers etc can be inserted.
- 7) Finally, all power/data/telephone accessories can be wired and fixed.

The Earth Loop Impedance Test can now be carried out.

INSTALLATION TIPS

Installation around columns.

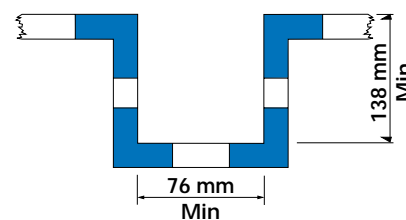

Accessory Boxes

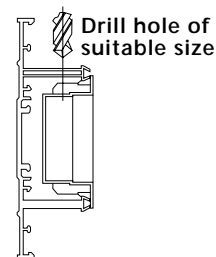

All boxes are on the same plain. Therefore, holes should be drilled from top or bottom to accommodate data and telephone cabling.

Crabtree accessories make a perfect match with Warwick trunking





UNDERFLOOR POWER TRACK



IN-CAVITY FLOOR TRUNKING



FLOOR BOXES



ALUMINIUM TRUNKING



SKIRTING TRUNKING (STEEL)



LIGHTING TRACK



Electrium

ELECTRIUM LIMITED

Forge Road
Willenhall
West Midlands
WV12 4HD
England.

Telephone: 01902 638800

Facsimile: 01902 638801

eMail: info@electrium.co.uk

web: www.electrium.co.uk

UK SALES OFFICE

Telephone: 01902 638818

Facsimile: 01902 603230

eMail: crabtree.sales@electrium.co.uk

PROJECT SALES OFFICE

Telephone: 01543 455218

Facsimile: 01543 453119

eMail: project.sales@electrium.co.uk

INTERNATIONAL SALES

Telephone: 01902 638808

Facsimile: 01902 603231

eMail: export@electrium.co.uk